

SOLAR R 20x20
Counters

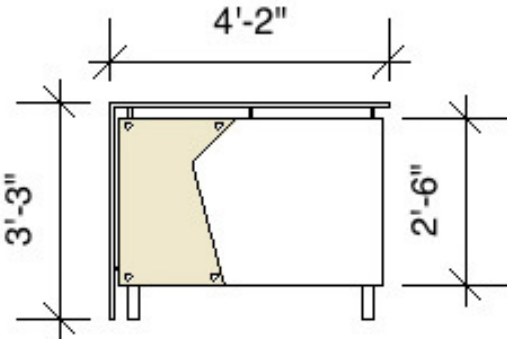

RECEPTION COUNTER
84 lbs

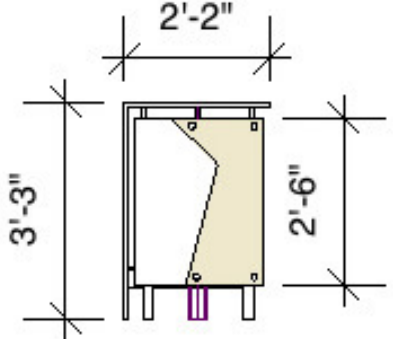

BACKWALL COUNTER
67 lbs